



# AV-30-E

## Pilot's Guide



© 2020 - 2022 uAvionix Corporation. All rights reserved.

uAvionix Corporation  
Bigfork, MT

[www.uavionix.com](http://www.uavionix.com)  
[support@uavionix.com](mailto:support@uavionix.com)

Except as expressly provided herein, no part of this guide may be reproduced, transmitted, disseminated, downloaded, or stored in any storage medium, for any purpose without the express written permission of uAvionix. uAvionix grants permissions to download a single copy of this guide onto an electronic storage medium to be viewed for personal use, provided that the complete text of this copyright notice is retained. Unauthorized commercial distribution of this manual or any revision hereto is strictly prohibited.

uAvionix® and Ping® are registered trademarks of uAvionix Corporation and may not be used without express permission of uAvionix.

AV-30, AV-30-E, AV-30-C, AV-Link-E, AV-Link-C, AV-Mag, BeaconX, tailBeaconX, and skyBeaconX are trademarks of uAvionix Corporation and may not be used without express permission of uAvionix.

Patents [uavionix.com/patents](http://uavionix.com/patents)

# 1 Revision History

Revision	Date	Comments
A	6/2/2020	Initial release
B	5/4/2021	Add AV-Link feature Add traffic display feature Add transponder control feature
C	5/20/2021	Section 7.5.5 Correction of non-slaved DG
D	7/22/2021	Added features of tailBeaconX and software update aiding features.
E	1/5/2022	Added AeroCruze 100/TruTrak Vizion autopilot control feature.
F	4/12/2022	Added AV-Mag external magnetometer.
G	10/11/2022	Added Set Altitude (SALT) visual alert. Changed TRUTRAK to AEROCRUZE. Added Trio PRO PILOT autopilot support. Added AV-Link-E reset feature. Added direct turn adjustment of barometer and heading bug. Added overlay elements on DG screens to support altitude controlling autopilots. Modified heading bug display to synchronize with autopilot usage. Modified PUSH-SET menu sequences to better support autopilot inputs. Missing magnetometer calibration now flagged with “MAG CAL” rather than “NO MAG”. Added a “zero out” action of the DG adjustment if using AV-Mag. Added table of checks and alerts for stored parameter integrity. Added three new autopilot heading modes and descriptions. Added GPS error messages table. Added AI

		screenshots illustrating 1:3, 2:3, 3:3 default screens.
--	--	---

## **2 Warnings / Disclaimers**

All device operational procedures must be learned on the ground.

uAvionix is not liable for damages arising from the use or misuse of this product.

This equipment is classified by the United States Department of Commerce's Bureau of Industry and Security (BIS) as Export Control Classification Number (ECCN) 7A994.

These items are controlled by the U.S. Government and authorized for export only to the country of ultimate destination for use by the ultimate consignee or end-user(s) herein identified. They may not be resold, transferred, or otherwise disposed of, to any other country or to any person other than the authorized ultimate consignee or end-user(s), either in their original form or after being incorporated into other items, without first obtaining approval from the U.S. Government or as otherwise authorized by U.S. law and regulations.

### 3 Limited Warranty

uAvionix products are warranted to be free from defects in material and workmanship for two years from the installation of AV-30-E on the aircraft. For the duration of the warranty period, uAvionix, at its sole option, will repair or replace any product which fails in normal use. Such repairs or replacement will be made at no charge to the customer for parts or labor, provided that the customer shall be responsible for any transportation cost.

Restrictions: This warranty does not apply to cosmetic damage, consumable parts, damage caused by accident, abuse, misuse, fire or flood, theft, damage caused by unauthorized servicing, or product that has been modified or altered.

Disclaimer of Warranty: IN NO EVENT, SHALL UAVIONIX BE LIABLE FOR ANY INCIDENTAL, SPECIAL, INDIRECT OR CONSEQUENTIAL DAMAGES, WHETHER RESULTING FROM THE USE, MISUSE, OR INABILITY TO USE THE PRODUCT OR FROM DEFECTS IN THE PRODUCT. SOME STATES DO NOT ALLOW THE EXCLUSION OF INCIDENTAL OR CONSEQUENTIAL DAMAGES, SO THE ABOVE LIMITATIONS MAY NOT APPLY TO YOU.

Warranty Service: Warranty repair service shall be provided directly by uAvionix. Proof of purchase for the product from uAvionix or authorized reseller is required to obtain and better expedite warranty service.

Please email or call uAvionix support with a description of the problem you are experiencing. Also, please provide the model, serial number, shipping address and a daytime contact number.

You will be promptly contacted with further troubleshooting steps or return instructions. It is recommended to use a shipping method with tracking and insurance.

## 4 Table of Contents

1	Revision History .....	3
2	Warnings / Disclaimers.....	5
3	Limited Warranty .....	6
4	Table of Contents .....	7
5	AV-30-E System Information .....	11
5.1	System Description.....	11
5.2	System Functions .....	12
6	Unit Interfaces .....	14
6.1	Aircraft Systems Interfaces.....	14
6.2	Power Input (Required) .....	15
6.3	Pitot and Static Interfaces (Required) .....	16
6.4	GPS Interface (Optional) .....	16
6.5	OAT Probe (Optional).....	17
6.6	Audio Output (Optional).....	17
6.7	Transponder Control (Optional) .....	17
6.8	AV-Link-E Interface (Optional).....	17
6.9	Magnetometer Aiding (Optional) .....	18
6.10	Autopilot (Optional).....	18
7	User Interface.....	20
7.1	Startup and Common Controls .....	20
7.2	“PUSH-SET” Control .....	21
7.3	Direct-Turn .....	22
7.4	User Interface Customization .....	22
7.4.1	AI Mode Customization .....	24
7.4.2	Edit Presented Data.....	26
7.5	AI Mode Display Components .....	26
7.5.1	Basic Components.....	26
7.5.2	Customizable Data Overlay Fields .....	27

7.5.3	Attitude / Slip.....	28
7.5.4	Airspeed Indicator .....	29
7.5.5	Flight Direction Indicator .....	31
7.5.6	Barometric Corrected Altitude Indicator.....	31
7.5.7	AoA Indication.....	32
7.5.8	Vertical Trend Indicator .....	33
7.5.9	G-Load Indicator .....	35
7.5.10	Text Fields .....	35
7.5.11	Accessing Reversionary AI .....	36
7.6	DG Mode Display Components .....	36
7.6.1	DG Mode Customization .....	36
7.6.2	Non-Slaved Heading Mode .....	36
7.6.3	GPS HSI Mode .....	37
7.6.4	GPS ARC Mode.....	38
7.6.5	Operational Aspects.....	38
7.6.6	Accessing Reversionary AI .....	40
7.7	AI / DG Displayable Parameters .....	40
7.8	MFD Mode.....	42
7.8.1	Features.....	42
7.8.2	Firmware Update .....	43
7.8.3	Display Functions.....	44
7.8.4	Display Zoom.....	44
7.8.5	Target Relative Altitude.....	45
7.8.6	Target Airspeed .....	46
7.8.7	Target Tracking Function .....	46
7.8.8	Accessing Reversionary AI .....	47
7.8.9	Traffic Mode Configuration.....	48
7.9	Reversionary AI.....	51
7.10	Transponder Control.....	51



7.10.1	Status .....	51
7.10.2	Changing Squawk.....	52
7.10.3	Changing Flight ID .....	53
7.10.4	Changing Transponder Mode .....	53
7.10.5	To Send IDENT .....	53
7.10.6	Quick Squawk VFR.....	53
7.11	Brightness Menu .....	54
8	User Interface and Font Style Options.....	55
9	Alerts and Alert Limits .....	56
9.1	Airframe Envelope Alerts .....	56
9.2	Altitude Alert .....	57
10	Internal Battery Operation .....	58
10.1	General .....	58
10.2	Battery Transition Logic.....	58
10.2.1	Power-On Self-Test (Pre-Flight).....	58
10.2.2	Power Loss, Airspeed Above 40 Knots (In-Flight) .....	59
10.2.3	Power Loss, Airspeed Below 40 Knots (On-Ground).....	59
10.3	Battery Charge Status .....	59
11	AoA Operation and Configuration.....	61
11.1	Operational Methodology.....	61
11.2	Configured Limits.....	62
11.3	Stable Flight Conditions.....	63
11.4	Setting AoA Upper Limit .....	63
11.5	Setting AoA Lower Limit .....	64
11.6	AoA Alert Types and Thresholds .....	65
11.7	Flap Setting Observations .....	65
12	Setup Menu.....	67
12.1	Pilot-Accessible Setup Menu .....	67
12.2	Non-Pilot Accessible Install Menu.....	69

13	AV-Link-E .....	70
13.1	Overview .....	70
13.2	Additional Required Equipment .....	70
13.3	Connecting .....	71
13.4	Home Page .....	72
13.4.1	Settings.....	72
13.4.2	Status .....	72
13.4.3	Device Information .....	72
13.4.4	Navigating to Other Pages .....	73
13.5	Wi-Fi Settings Page.....	73
13.5.1	ADS-B Receiver Settings .....	73
14	Autopilot .....	76
14.1	Selecting Heading .....	77
14.2	Selecting Altitude.....	77
14.3	Selecting Vertical Speed .....	77
14.4	Selecting Autopilot Mode .....	78
15	Stored Data Integrity Check .....	79
16	Operating Limits & System Specifications .....	81

## 5 AV-30-E System Information

### 5.1 System Description

The uAvionix AV-30-E is a fully digital multi-mode instrument that mounts in the legacy 3-1/8" round instrument panel. It can be field configured as either an Attitude Indicator (AI), a Directional Gyro (DG) indicator or Multi-Function Display (MFD). It is fully self-contained with dual-precision inertial and pressure sensors and allows for a wide variety of pilot customization. Transponder control is available in both AI and DG modes.



Figure 1 - AV-30-E Multi Mode AI/DG/MFD – Basic Display

When configured as an AI, primary attitude and slip are always displayed. The unused portions of the display area can be customized by the pilot to show a variety of textual and graphical data overlay fields. Three pages may be customized by the pilot while a fourth page presents a fully decluttered view of only attitude and slip, while optionally presenting transponder controls.

When configured as a Directional Gyro (DG), direction of flight information is presented. The flight direction can be configured to be presented as a non-slaved heading, aided by an optional internal magnetometer, or inertially stabilized GPS track when connected to an external GPS navigator. Multiple display presentations, including compass rose, GPS HSI, and GPS Arc views can be selected by the pilot. The unused portions of the display area can similarly be configured for a variety of textual data-overlays.

When configured as a Multi-Function Display (MFD) and connected to AV-Link-E, live airborne and ground traffic from a supported Wi-Fi capable Automatic Dependent Surveillance-Broadcast (ADS-B) receiver is available.

A presentation of the decluttered attitude and slip, optionally with transponder controls, is available as the last presentation in DG and MFD mode.

In AI or DG operating modes, the pilot may select from multiple visual styles which are intended to improve visual compatibility with legacy aircraft instrumentation and preserve the look-and-feel of older aircraft applications.

A wide variety of supplemental functions, including audio alerting, derived angle of attack presentation, G-load display, and more are provided. An internal, rechargeable battery allows for operation for a nominal 1 hour in the event of aircraft power loss and 30 minutes minimum under all operating temperature conditions.

When installed as a non-required instrument (not replacing the existing approved AI or DG), the functional mode of the unit can be toggled between AI and DG by pressing and holding the rotary knob for 3 seconds.

## **5.2 System Functions**

### Primary Functions

- Primary Attitude (AI Mode)
- Primary Slip (AI Mode)
- Primary Direction of Flight indication (DG Mode)

### Supplemental Functions

- Indicated Airspeed
- Altitude
- V-Speeds
- Angle of Attack
- Vertical Trend
- Vertical Speed
- Set Altitude (SALT)
- Set Vertical Speed (SVS)

- Heading
- Bus Voltage
- G Load
- Outside Air Temperature
- True Airspeed
- Density Altitude
- GPS Navigator/Waypoint Data
- GPS Navigator Nav Data
- GPS Navigator Route Line
- Heading Bug
- Traffic page (requires AV-Link-E)
- Transponder control (AI / DG / MFD Mode)
- Autopilot control

#### Audio and Visual Alerting Functions

- AoA Alerting
- G Limit Alerting
- Excessive Roll Alerting
- Set Altitude Alerting

#### Miscellaneous Functions

- Internal Battery Operation
- Auto/Manual Brightness

## 6 Unit Interfaces

### 6.1 Aircraft Systems Interfaces

The following describes each of the AV-30-E system interconnects for both the AI, DG and MFD installation configurations. Note that, as shown in Figure 2 – AV-30-E Aircraft Systems Interfaces – AI Mode, that some interfaces are optional and may not be available in each installation.

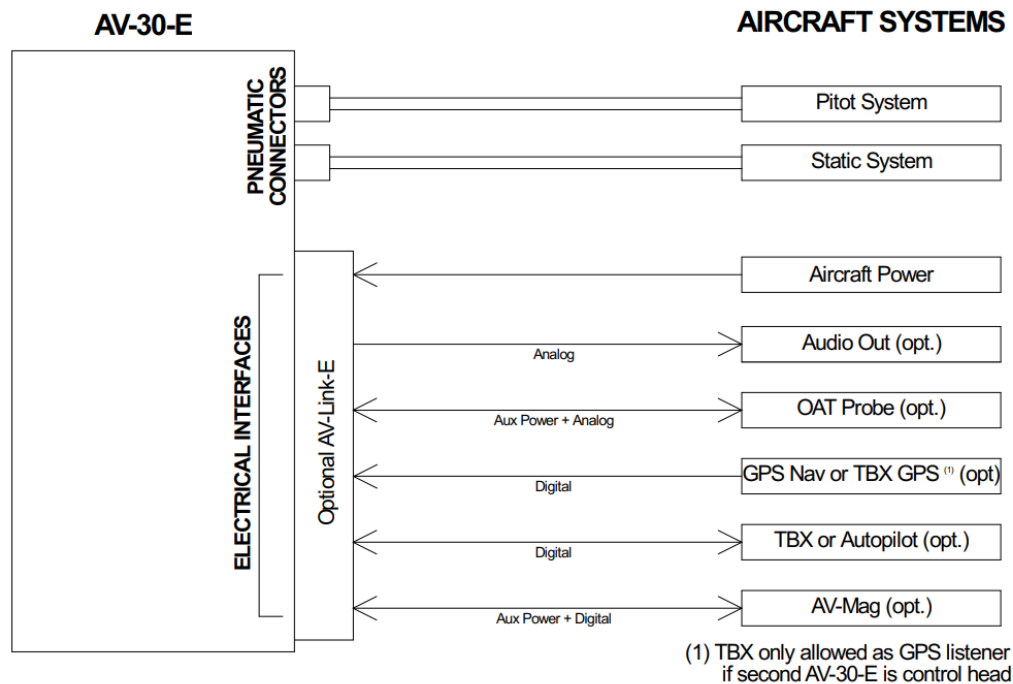

Figure 2 – AV-30-E Aircraft Systems Interfaces – AI Mode

When installed as a DG, no audio outputs are supported, and some air data related parameters are only available when the optional OAT probe is equipped.

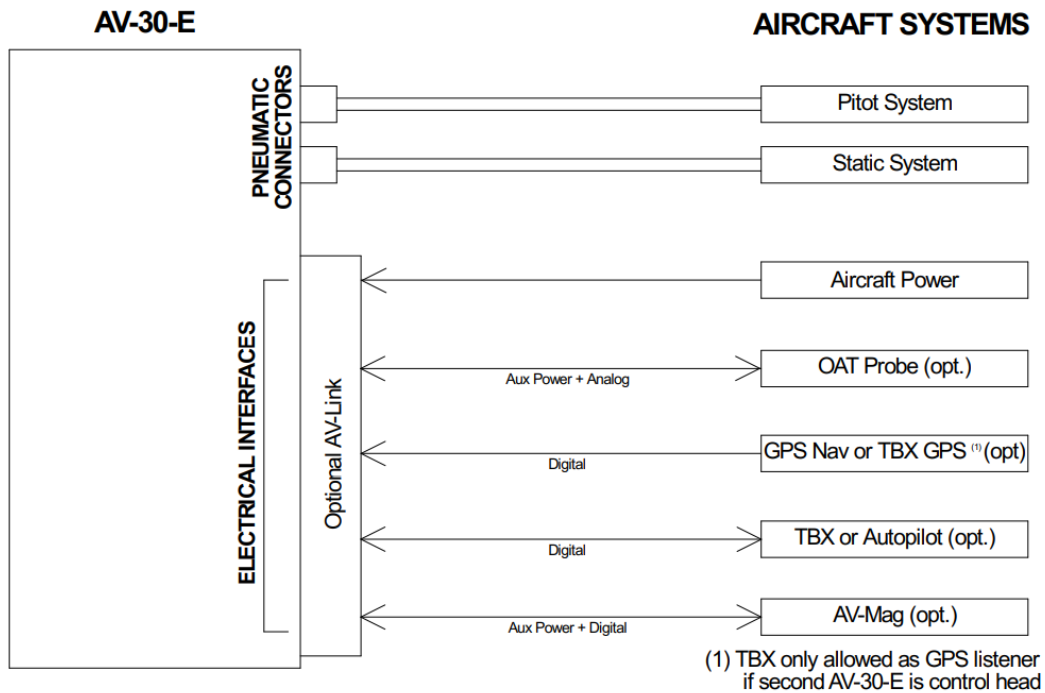

Figure 3 – AV-30-E Aircraft Systems Interfaces – DG Mode

## 6.2 Power Input (Required)

Power input is required in both AI, DG and MFD configurations and each unit has a dedicated circuit breaker. The power input is internally connected, and diode protected with the unit's internal battery via a processor-controlled switch. This architecture allows the unit to continue operation if external power fluctuates or is completely lost.

When external power is supplied to the AV-30-E, there is no mechanism to turn the unit off. When operating on battery, the unit may be forced off by pressing the left and right buttons simultaneously until the unit shuts off. See § 10 - *Internal Battery Operation* for more information.



The AV-Link-E accessory is not powered by the AV-30-E internal battery. Wi-Fi traffic data provided to the MFD mode will be unavailable during a power loss.

### **6.3 Pitot and Static Interfaces (Required)**

Pitot and static connections are required for AI, DG, and MFD mode.

Airspeed, altitude, derived angle of attack (AoA), True Airspeed (TAS), Density Altitude (DALT), DG heading, and traffic altitude all require pitot and static connections as they are based on either altitude or airspeed measured from those connections.

When installed as an MFD, the pitot and static connections are required for traffic relative altitude. If unconnected, incorrect relative altitudes may be displayed.

### **6.4 GPS Interface (Optional)**

The Global Positioning System (GPS) interface is an optional RS-232 serial input that is compatible with the industry standard Aviation output provided by most panel mounted GPS units or NMEA serial interfaces provided by most hand-held GPS units.

The GPS navigator output is a text/binary protocol that contains situational awareness information such as ground speed, track, distance to destination, cross track, etc., and is typically utilized by remote mapping/display products to provide additional pilot awareness.

This output does not provide IFR compliant lateral or vertical guidance, therefore all deviation related data presented is for VFR operations only.

The AV-30-E does not alter the data obtained from the GPS navigator and simply displays the received data in a textual or graphical format as configured by the pilot.

The AV30-E can use a parallel input from a BeaconX to drive its GPS functions. A second AV-30-E is required to act as the BeaconX Transponder Controller as per section 6.7. Only one AV-30-E may receive transponder data but both may receive GPS data from a single BeaconX.



## 6.5 OAT Probe (Optional)

The optional Outside Air Temperature (OAT) probe interface is compatible with the industry standard “Davtron” (C307PS) probe which is mounted external to the aircraft. OAT data is available as a textual data overlay and is used to compute temperature dependent data such as True Airspeed (TAS) and Density Altitude (DALT). Each AV-30-E requires a dedicated probe. A single OAT probe cannot be shared between multiple units.

The OAT probe is automatically detected by the system, and when present, allows temperature related parameters to be selected for display. If the OAT probe is not detected, display of these parameters is inhibited.

## 6.6 Audio Output (Optional)

The optional audio output provides audio alerts for the various alerting conditions. This output is typically connected to the aircraft’s non-switched audio input on the audio panel. Audio alerting thresholds and alert enablement are configured by the pilot in the Setup Menu.

Audio alerting is only supported when configured as an AI.

## 6.7 Transponder Control (Optional)

The AV-30-E has the option of being the control interface for select uAvionix transponders (including the BeaconX family). This provides pressure altitude, mode, squawk code and IDENT information to the transponder, and displays status and annunciations from the transponder.



The transponder is not powered by the AV-30-E internal battery. Transponder operations will be unavailable during a power loss.

Note that the BeaconX output can be shared in parallel between two AV-30-E devices. One device must act as the Transponder Controller and the other may use the BeaconX as a GPS-only input.

## 6.8 AV-Link-E Interface (Optional)

The AV-30-E has the option of displaying ADS-B traffic using AV-Link-E as an integrated Wi-Fi bridge that allows for communication between AV-30-E

and Wi-Fi capable ADS-B receivers. The AV-30-E will display a separate navigational page with traffic when configured and connected to a supported receiver.



The AV-Link-E accessory is not powered by the AV-30-E internal battery. Wi-Fi traffic data provided to the MFD mode will be unavailable during a power loss.

## 6.9 Magnetometer Aiding (Optional)

Two magnetometer aiding devices are available; the AV-Mag external magnetometer and the internal magnetometer. Support for the AV-Mag external magnetometer is available in software version 2.3.0 or later and requires installation in the aircraft. If the AV-30-E is equipped with an internal magnetometer it will be automatically detected by software in versions 2.1.1 and later. Both types of magnetometers require calibration before use. Only one magnetometer can be used at a time. See Section 13 of the Installation Manual for details on how to calibrate either of the AV-30-E magnetometers.



The AV-Mag is powered by the AV-30-E. During a power loss, the AV-Mag will be powered by the AV-30-E internal battery and continue to provide heading data.

## 6.10 Autopilot (Optional)

The AV-30-E has the option to act as an altitude and direction control input for the BendixKing AeroCruze 100/xCruze 100/TruTrak Vizion (385 and PMA) autopilot or the Trio 'Pro Pilot' autopilot. The autopilot and AV-30-E are connected to one another via half duplex RS-232 serial.

The AV-30-E sends a Set Altitude (SALT), a current altitude, a Set Vertical Speed (SVS), a desired direction, and a current direction to the autopilot. The pilot controls these via the center knob PUSH-SET menu and displays the data via graphical or textual overlay fields.

There are four autopilot control modes. Each mode uses a different combination of desired direction and current direction to achieve different types of flight goals as show in Table 14-1- *Autopilot Modes*. For further details on Autopilot control see section 14 *Autopilot*.

## 7 User Interface

### 7.1 Startup and Common Controls

The initial power-on splash screen presents the company logo, unit model number, and the currently installed software version.



Figure 4 – Splash Screen

Operation in AI, DG and MFD modes share the following common user interface controls.

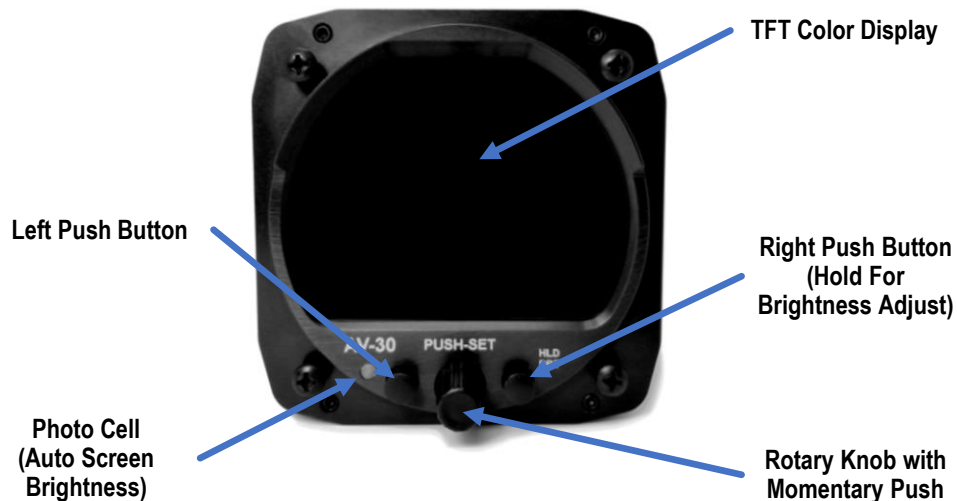

Figure 5 - Common User Interface Components

When installed as a non-required instrument (not replacing the existing approved AI or DG), press and hold the center knob to switch between AI, DG, and MFD modes when the Function Lock feature is disabled. If the Function Lock feature is enabled, then the pilot may not switch between modes. See *AV-30-E Installation Manual UAV1004234-001* for configuring the Function Lock feature.

## 7.2 “PUSH-SET” Control

Activate the PUSH-SET window for accessing context menus and settings by momentarily pushing and releasing the main rotary knob.

This activates a window along the bottom of the display to allow various parameters to be adjusted with the rotary knob. Momentarily push and release the knob to scroll through each option.

When you reach the option to change, rotate the knob to scroll through all available values for this option. If the range setting has reached a limit, the left or right indication arrows will indicate which direction the rotary knob will change the setting. Both arrows are visible when the setting can be increased or decreased.

Momentarily push and release the knob to save the updated option value. The settings window will disappear, and the new setting is saved. In some cases where multiple settings are related, the window will stay open and advance to the next related setting.



The parameters that can be adjusted will vary, based on the mode of the unit and the current configuration of the display. Figure 6 shows how the barometric setting is adjusted when altitude has been configured for display.



Figure 6 - Push-Set Example – SET BARO

## 7.3 Direct-Turn

Commonly used parameters may be adjusted quickly by simply turning the center knob.

In AI mode, the barometric pressure setting is adjusted by simply turning the knob to bring up the 'SET BARO' window.

In DG mode, the heading bug is adjusted by simply turning the knob to bring up the 'HDG BUG' window.

All adjusted values are active immediately. After adjustment, push and release the center knob to dismiss the window. If after 30 seconds the knob is not pressed, the window will be dismissed automatically.

## 7.4 User Interface Customization

Each display mode (AI or DG) is customizable to display data in a format and position on the screen according to pilot preference. Each display mode has multiple, customizable screens that the pilot may switch between during flight. Each screen can be customized to show different sets of data. For example, AI screen 1:3 (first of three) may be configured to show different types of air data, while screen 2:3 (second of three) is configured to show Angle of Attack and Vertical trend, while screen 3:3 (third of three) is configured to show GPS navigation waypoints and related data.



Figure 7 - Screen 1 of 3 showing Air Data and DG Heading



Figure 8 – Screen 2 of 3 showing GPS Ground Track, AoA, and Vertical Trend



Figure 9 - Screen 3 of 3 showing Waypoint Data and SALT

Note that the fourth page is a simplified reversionary page and is not configurable. It only displays minimally required information.



In general, it is suggested that the display be customized prior to flight, and that each page be setup for the different basic modes of flight operations (Departure, En route, Terminal) prior to actual flight operations.

#### 7.4.1 AI Mode Customization

Pressing the lower left options MENU button will bring up the first menu, which is the user interface customization menu. In this mode, the cursor can be moved to each customizable area by rotating the rotary knob.





Figure 10 – UI Customization, Menu Entry

The currently selected field will be indicated by a darkened block with a cyan bracket. Rotating the knob left and right will change the currently selected field. To edit the overlay value presented in the currently highlighted field, push the rotary knob.



Figure 11 – UI Customization - Field Selection

A second push of the lower left options MENU button will bring up the second menu. Menu options related to the current screen are displayed.

## 7.4.2 Edit Presented Data

The following shows the display when the edit mode is active. Rotating the knob left and right will then select from the various overlay values that can be presented in the selected field.



-  When the desired data type is presented, pressing and releasing the knob will accept the current value, and the edit mode will remain active.
-  Press the DONE shown in the lower left button to accept the current value and exit the UI customization mode.



Figure 12 - Display Edit Value

Take note that not all data values can be presented in each editable field area. For example, airspeed will only be displayed on the left main area and altitude will only be displayed on the right side. Additionally, when operating in the DG mode, the available data displayed is different than when operating in the AI mode.

## 7.5 AI Mode Display Components

### 7.5.1 Basic Components

Figure 13 – Basic AI Mode User Interface shows the basic AI with all customizable data overlay fields turned off.

The data shown cannot be disabled or customized:



Figure 13 – Basic AI Mode User Interface

### 7.5.2 Customizable Data Overlay Fields

Figure 14 - AI Mode, Customizable Field Locations shows the locations of the inner and outer customizable fields when operating in the AI mode.

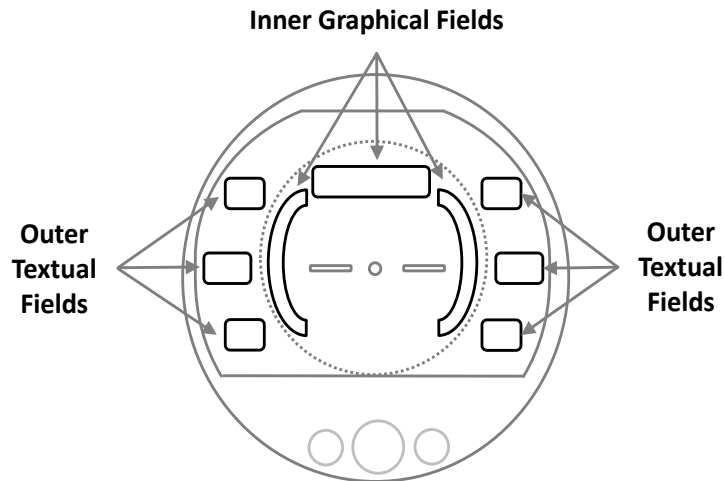

Figure 14 - AI Mode, Customizable Field Locations

There are three independent pages on this screen that may be custom configured as desired by the pilot.

Figure 15 – Data Overlay Examples shows an example of the pilot customizable data overlays (both textual and graphical), located in the non-utilized areas of the display area.



Figure 15 – Data Overlay Examples

When in AI mode, there are three independently customizable pages which are selected round-robin fashion by momentarily pushing and releasing the page selection button repeatedly. The active page is displayed as 1:3, 2:3 and 3:3 on the lower right corner of the display.

A fourth, fully decluttered page allows all supplemental information to be hidden, leaving just attitude and slip displayed. This is accessed by momentarily pushing and releasing the page selection button a fourth time. Return to page 1 by momentarily pushing and releasing the page selection button.

### 7.5.3 Attitude / Slip

The basic display of attitude and slip consists of a traditional attitude indicator display and slip-ball as follows:



Figure 16 - AI Mode, Attitude Indicator

- ➡ On initial startup the red ALIGN flag will flash, indicating that the attitude is still stabilizing.
- ➡ The aircraft should be held as motionless as possible during the alignment process.
- ➡ If power is removed from unit during the alignment phase the unit will remain on battery power until it has aligned.

**When the ALIGN annunciator is displayed, the presented attitude may be incorrect. If ALIGN annunciator does not extinguish after 3 minutes, please contact uAvionix support.**

#### 7.5.4 Airspeed Indicator

Indicated airspeed is configured for display on the left side of the screen. The configured units (KTS or MPH) are displayed below the speed value.



Figure 17 – AI Mode, IAS Indicator

The inner arc is a color-coded V-Speed band that rotates to show the configured V-Speed limits against the non-moving white tick mark. The lower arc portion below  $V_{s1}$  provides a red colored slow-speed band that is only displayed when the airspeed has been above  $V_{s1}$  for a given flight.

The color of the indicated airspeed numerals will turn yellow when operating in the yellow speed arc, red when operating in a red speed arc, but are otherwise white.



Figure 18 - AI Mode, V-Speed Limits



On initial startup, the airspeed field will display dashes while sensor stabilization occurs.



Airspeed display units and V-Speed limits are configured during installation and are not pilot accessible.

## 7.5.5 Flight Direction Indicator

The upper portion of the AI can be configured to display direction of flight in the form of either DG heading or GPS track.

Both modes support a magenta heading bug, and the GPS track mode supports an additional green bearing-to indicator. The heading bug may be used as a simple directional reference. In the case where the AV-30-E is connected to an autopilot, the heading bug is used as the direction input to the autopilot (See §6.10).

If this field is configured to display GPS track, and no GPS is detected, an amber “NO DATA” will be displayed. If a GPS is detected but it has not achieved a fix or is otherwise not providing useful data, “NO GPS” will be displayed.

If magnetometer aiding is configured but calibration is not complete the “MAG CAL” flag is indicated. If the AV-30-E is not receiving the magnetometer sensor data, the “NO MAG” flag is indicated.

If either the heading bug or the bearing-to bug are off the left or right sides of the screen, a colored arrow will show the shortest-turn direction to the corresponding bug. To align the heading bug to current heading, use the PUSH-SET center knob to select HDG BUG, then push and hold the center knob for about 2 seconds and the heading bug will snap to the current heading.



Figure 19 - AI Mode, Direction Indication, Bearing To Off-Screen

## 7.5.6 Barometric Corrected Altitude Indicator

Barometric corrected altitude (BCA) can be configured for display on the right side of the screen and shows the barometric altitude in feet. When this field is configured for altitude display, the lower right field will be

locked to the barometric setting and cannot be modified to display a different parameter.

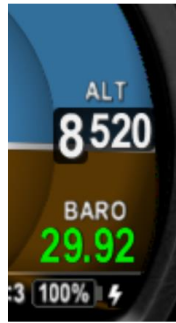

Figure 20 - AI Mode, Altitude Indicator

Adjust the barometric setting utilizing the rotary knob. See §7.2 - “PUSH-SET” for addition details.

Barometric setting in inches of Mercury (INHG) or millibars (MB) are selected during installation. It is not a pilot accessible setting.

- ➡ On initial startup, the field will display dashes while sensor stabilization occurs.
- ➡ On unit power-down, the current field elevation and barometric pressure are stored in internal non-volatile memory. On the next power-up, this field elevation is used to compute an estimated barometric setting, potentially reducing the required adjustment amount required by the pilot. During this process, the barometric value will be shown in light grey.

### 7.5.7 AoA Indication

Derived Angle of Attack can be configured for display in the inner left area of the screen and consists of a series of colored stacked bars that indicates the current AoA relative to the configured minimum and maximum limits.



The lowest green bar corresponds to a current AoA matching the configured lower limit point. The first red bar corresponds to a current AoA matching the configured upper limit.



AoA limit points are pilot selectable and are set in the pilot accessible Setup Menu.

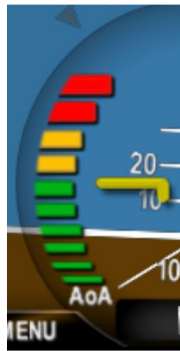

Figure 21 - AI Mode, AoA Indication

AoA is determined by the difference between the aircraft's pitch angle and the path through the air. See §11 - AoA Operation and Configuration for additional details on the AoA operation and setup.

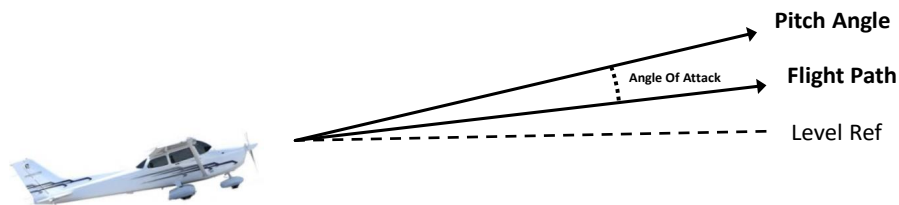

Figure 22 – AoA Computation

### 7.5.8 Vertical Trend Indicator

Vertical trend can be configured for display in the inner right area of the screen and consists of a white tick mark on a background scale. The upper and lower limits of the scale correspond to  $\pm 1000$  feet per minute.

This display cannot be used as required vertical speed indicator, only as augmented data.

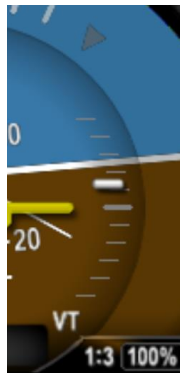

Figure 23 - AI Mode, Vertical Trend Indication

If the AV30 is configured for an optional autopilot, the vertical trend indicator will display a magenta Set Vertical Speed (SVS) bug.



Figure 24 - AI Mode, Vertical Trend Indicator and SVS Bug

If the SVS bug is above or below the display limits of the vertical Trend indicator, a second magenta arrow will appear alongside the bug pointing up or down to indicate the SVS value is above or below the scale.

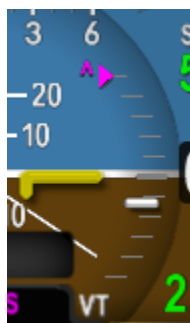

Figure 25 - SVS Bug value greater than scale

## 7.5.9 G-Load Indicator

The current G-Load can be configured for display on the inner right or inner left area of the screen and consists of a ball marker on a background scale. The upper and lower limits of the scale correspond to the upper and lower G limits set in the Setup Menu.

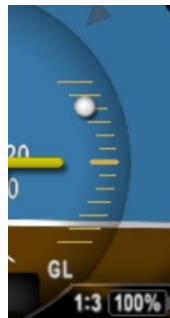

Figure 26 - AI Mode, G-Load Indication

The center most tick mark represents 1.0 G. Values above the center mark represent positive G, while those below represent less than 1.0 G levels. The scale markers will change color based on G limits set.

See §9 - Alerts and Alert Limits for additional information about G limit alerts.

## 7.5.10 Text Fields

The four corners of the display screen can be configured to show various textual parameters. In this example, distance to waypoint, waypoint identifier, Set Altitude, and barometric pressure are displayed.



Figure 27 - AI Mode, Text Fields



If a given parameter is invalid or currently unavailable, it will display dashes.



See §7.7 - AI / DG Displayable Parameters for the list of parameters that can be displayed in these fields.

### 7.5.11 Accessing Reversionary AI

A reversionary style display showing attitude and slip is available as the fourth screen in AI mode. Push and release the right button multiple times to engage this screen. Push and release the right button again to return to the first (1:3) AI screen. When connected to a transponder, this screen provides control and monitoring of the transponder as detailed in §7.9 - Reversionary AI. This reversionary screen cannot be customized by the pilot.

## 7.6 DG Mode Display Components

### 7.6.1 DG Mode Customization

The DG customization mode is like the AI customization and the same methods are used to customize screens and fields.

The upper most field selects the base direction indication. The options are a heading ROSE, a GPS ground track horizontal situation indicator (HSI), and a GPS ground track ARC.

DG mode has three customizable screens plus a reversionary AI screen for transponder control.

### 7.6.2 Non-Slaved Heading Mode

Figure 28 – Basic DG Mode User Interface shows the non-slaved DG heading mode (DG HDG). Six textual fields are available for customization.



Figure 28 – Basic DG Mode User Interface

Several aiding modes are available to assist with heading stability. That includes the use of an external magnetometer (AV-Mag). When configured for AV-Mag aiding, long term heading stability will be excellent, but the device is still non-slaved, meaning the user can adjust the DG heading.

### 7.6.3 GPS HSI Mode

The display type can also be configured to show GPS navigation data when connected to an external GPS navigator and presented in the traditional HSI format:



Figure 29 – GPS HSI Mode

## 7.6.4 GPS ARC Mode

The display type can also be configured to show GPS track in an ARC mode, showing a map style presentation of the current waypoint and current navigational leg.



Figure 30 – GPS ARC Mode

Note: The entire programmed flight plan is not displayed, only the current navigation leg and current waypoint.

The display scale is adjusted by rotating the rotary knob and represents the display distance from the ownship icon to the outer compass ring. The following scales may be selected for display:

**Selectable Display Scales:  
1, 2, 5, 10, 20, 50 and 100 N Mi**

☞ All GPS deviation data is limited to VFR operations only, as indicated by the Nav Mode indication (“VFR”).

## 7.6.5 Operational Aspects

The following applies to operation in DG mode.

- As with the AI mode, three customizable pages can be setup by the pilot. Each page can be configured to show any of the above three display modes.
- Non-Slaved Heading mode requires the pilot to set the initial heading and correct the heading as required based on the compass. The system will initialize to the last set heading on shutdown, except when an AV-Mag external magnetometer is installed. Refer to AV-30-E Installation Manual UAV-1004234-001 for information regarding the hard calibration procedure.
- A pilot entered DG adjustment value can be cleared by entering the PUSH-SET menu, advancing to DG ADJ, then pushing and holding the center knob for 2 seconds. The heading will snap to the value computed by the AV-30-E and the user entered adjustment will be set to zero. Note that this only applies when the AV-Mag is installed.
- If magnetometer aiding is configured but calibration is not complete the “MAG CAL” flag is indicated. If the AV-30-E is not receiving the magnetometer sensor data, the “NO MAG” flag is indicated.
- GPS HSI and ARC modes are for VFR operations only. No vertical deviations are shown, and lateral deviations are not scaled for approach / IFR operations.
- Air data / temperature related parameters (TAS, DALT, OAT) are only available if the DG has been connected to and OAT probe, otherwise they will not be selectable for display.
- The currently displayed GPS track may optionally be gyroscopically stabilized, allow smoother operation when in turns. This option is configured in the pilot accessible Setup Menu (GPS Track Stabilization).
- When GPS Track is the base direction, any GPS error conditions that might occur are indicated according to Table 7-1- GPS Error Messages.

Table 7-1- GPS Error Messages

GPS Error Message	Meaning
NO DATA	No data/messages are being received over the serial port.
NO GPS	No GPS Fix or some other condition is preventing the GPS receiver from providing useful data.
NO COURSE	No waypoint navigation information has been received yet. This message is suppressed when BeaconX is the primary GPS.

### 7.6.6 Accessing Reversionary AI

A reversionary style display of attitude and slip is available from the traffic page. Push and release the right button to engage this screen. Push and release the right button again to disengage. When a transponder is interfaced, this page also allows control and monitoring of the transponder as detailed in §7.9 - Reversionary AI. This mode page cannot be customized by the pilot.

### 7.7 AI / DG Displayable Parameters

The following table shows which data fields can be displayed when operating in AI and DG modes.

The 'Graphical' presentation type indicates that the data is displayed in a graphical format (dial, tape, bug, etc.). The 'Textual' presentation type indicates that the data is displayed in text.

Table 7-2 - Data Overlay Types vs Operational Mode

Data Type	Presentation	AI Mode	DG Mode
Blank Overlay Field	N/A	✓	✓
Attitude	Graphical	✓	✓
Non-Slaved Heading	Graphical	✓	✓
Bus Voltage	Textual	✓	✓



G Load Value	Textual	✓	✓
G Load Indicator	Graphical	✓	✗
Indicated Airspeed <sup>(1)</sup>	Textual	✓	✗
Barometric Corrected Altitude <sup>(2)</sup>	Textual	✓	✓
Barometer Setting <sup>(3)</sup>	Textual	✓	✓
Angle of Attack	Graphical	✓	✗
Vertical Trend Indicator	Graphical	✓	✗
Vertical Speed	Textual	✓	✓
Set Altitude	Textual	✓	✓
Set Vertical Speed Bug <sup>(4)</sup>	Graphical	✓	✗
Outside Air Temp <sup>(5)</sup>	Textual	✓	✓
True Airspeed <sup>(5)</sup>	Textual	✓	✓
Density Altitude <sup>(5)</sup>	Textual	✓	✓
Direction Tape	Graphical	✓	✗
Direction Rose	Graphical	✗	✓
Direction Arc <sup>(6)</sup>	Graphical	✗	✓
Direction HSI <sup>(6)</sup>	Graphical	✗	✓
GPS Navigator Data <sup>(6)</sup>	Textual	✓	✓
GPS HSI Indicator <sup>(6)</sup>	Graphical	✗	✓
GPS Navigator Route <sup>(6)</sup>	Graphical	✗	✓
Heading Bug <sup>(7)</sup>	Graphical	✓	✓

(1) Only available in the middle-left overlay location

(2) Only available in middle-right overlay location

(3) Only available in lower-right overlay location

(4) Only available when Autopilot is installed and Vertical Trend Indicator is visible

(5) Only available when OAT sensor is installed

(6) Only available when a GPS navigator is installed

(7) Some autopilot modes will hide the heading bug

## 7.8 MFD Mode

When equipped, the AV-30-E can display real-time traffic data. To access the MFD mode page, ensure that SERIAL 3 is configured for 'AVLINK', and then push and hold the center button until the screen changes. If you are on the AI mode screen, you will change to the DG mode screen. If you are on the DG mode screen, you will change to the MFD mode screen. Push and hold the button one more time to change back to the AI mode screen.

This page will be accessible and display traffic (left example in Figure 31) only when AV-Link-E is connected to the AV-30-E according to the installation manual. If configured but not properly connected, the words "NO DATA" will be displayed in the center of the screen (see the right photo in Figure 31).



Figure 31 - AV-30-E Traffic Page



The AV-Link-E accessory is not powered by the AV-30-E internal battery. Wi-Fi traffic data provided to the MFD mode will be unavailable during a power loss.

### 7.8.1 Features

When AV-Link-E is installed and configured to connect to a Wi-Fi capable ADS-B receiver both airborne and ground traffic display are available.

Only Wi-Fi capable ADS-B receivers are supported. Bluetooth enabled ADS-B receivers are not supported.

ADS-B Wi-Fi receivers that have been confirmed as compatible include:

- Sentry
- Sentry Mini
- skyEcho2
- skySensor
- echoUAT
- Stratus 3 (in Open GDL Mode only)
- Dynon Avionics DRX
- Level Aviation iLevel 3 AW
  - BOM, iLevel 3 SW, and Astro Link should work
- SkyGuardTWX
- Stratux
- Falken Avionics FlightBox

This is not an exhaustive list.

Some of these receivers will require setting the AV-Link-E to a custom port value if the ADS-B receiver transmits GDL90 information on a port other than 4000 (default).

More receivers may be compatible using the AV-Link-E ADS-B Wi-Fi settings custom port setting. See §13.5.1 - ADS-B Receiver Settings to configure the AV-Link-E custom port setting.

### **7.8.2 Firmware Update**

After the AV-Link-E and AV-30-E have been installed, a firmware update may be required to enable the AV-Link-E features of the AV-30-E. See AV-30-E Installation Manual UAV1004234-001 for instructions on installing firmware. A minimum software version of 2.0.0 is required to support MFD Mode.

After the update, the AV-30-E MFD screen will display the words “NO DATA” until an attached AV-Link-E is installed, powered, and connected to your ADS-B receiver.

See §13.5.1 - ADS-B Receiver Settings for guidance for updating AV-Link-E and connecting to traffic sources.

### 7.8.3 Display Functions

Traffic display, both airborne and ground, are available. Traffic is represented by a chevron icon, pointing in the direction of travel. Traffic on the ground is colored brown and traffic in the air is colored cyan.

Traffic that has no heading is classified as an airborne obstacle and is represented by a cyan diamond icon.

In normal monitor mode, the screen will display active traffic and has a zoom function to permit the pilot to view traffic from 1 nautical mile (N Mi) to 40 nautical mile range. Due to the placement of the ownship icon, more distance is displayed forward of ownship than behind.

Concentric rings display hints on distance. There are three in total. Depending on the range selected, these represent the 1/3, 2/3 and full display distance. Each are marked with the current range distance. For example, at 1 nautical mile range setting, the rings are set at 0.33 N Mi, 0.66 N Mi, and 1 N Mi.



Figure 32 - Traffic Display

### 7.8.4 Display Zoom

Target detail will vary based on the current zoom level. This is to reduce visual clutter. As zoom is set to closer distances, extra target information will be placed next to the target icon. These include relative altitude to ownship and the speed vector extending from the front of the target.



Figure 33 - Traffic Display Zoom

### Selectable Display Scales: 1, 2, 5, 10, 15, 20, 30 and 40 NM

#### 7.8.5 Target Relative Altitude

Relative altitude is determined using real-time altitude information from ownship as well as each individual target. It is possible to have two types of altitude information: traffic pressure altitude and geometric altitude.

In compliance with DO-317C §2.3.5.15.1, the traffic relative altitude is calculated by either (1) using the pressure altitude of both aircraft or (2) if valid pressure altitude is unavailable, by using the geometric altitude of both aircraft. The relative altitude shown for traffic is positive when the target is higher than ownship and negative when the target is lower than ownship. If the same altitude type is not available for both ownship and the target, then no relative altitude is displayed for that target.

Note: AV-30-E must be connected to aircraft pitot and static pneumatic connections for correct relative altitudes to be displayed.



Figure 34 - Traffic Target Relative Altitude

Some uncertified advisory display products will use a combination of pressure altitude and geometric altitude for the calculation of the target relative altitude. This is not in compliance with DO-317C §2.3.5.15.1 and therefore may result in a difference between the relative altitude display on the AV-30-E and the other product.

Relative altitude is displayed in units of hundreds of feet. For example, a display of +335 indicates that the target is 33,500 feet above ownship. The “+” indicates the target is above ownship and the label is placed *above* the target icon. If the target is below ownship, then a “-” value is used, and the label is placed *below* the target icon.

### 7.8.6 Target Airspeed

Target airspeed is indicated by a vector line extending from the front of the target. A longer vector indicates that the target airspeed is faster than a different target with a shorter vector. This vector is visible only when the zoom range is 20 nautical miles or closer.

Tracking the target will provide detailed information about the target, including the current airspeed.

### 7.8.7 Target Tracking Function

Momentarily pushing and releasing the center button activates target tracking function. Use the rotary knob to select the target to track. Information details about the target will appear at the top of the display.

This information includes callsign or flight plan identifier, information source, type of aircraft, distance, altitude, and airspeed. If an information item is unavailable, then dashes “---” will appear for the item.

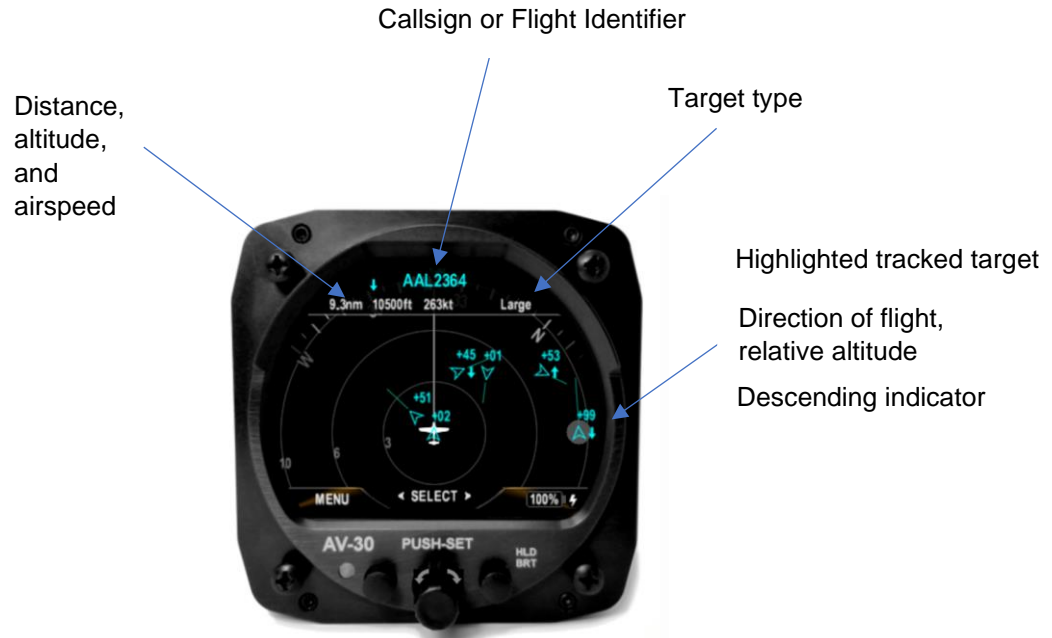

Figure 35 - Traffic Target Tracking Function

The screen will stay in tracking mode until disengaged with a push and release of the center button. During tracking, the zoom function is disabled.

### 7.8.8 Accessing Reversionary AI

A reversionary style display of attitude and slip is available from the traffic page. Push and release the right button to engage this screen. Push and release the right button again to disengage.



Figure 36 - Traffic Reversionary AI Activation

When a transponder is connected, this page also allows control and monitoring of the transponder as detailed in §7.9 - Reversionary AI. This mode page cannot be customized by the pilot.

### 7.8.9 Traffic Mode Configuration

The traffic mode has settings that can be configured for ownship identity, to prevent the ownship from being displayed as “ghost” aircraft, and traffic filtering for reducing the content displayed on the screen.

#### 7.8.9.1 Ownship ICAO

If your aircraft is not equipped with an ADS-B Out system, Air Traffic Control (ATC) can rebroadcast your Mode-C target to nearby aircraft using Automatic Dependent Surveillance – Rebroadcast (ADS-R). ADS-R is a client-based service that relays ADS-B information transmitted by aircraft on one line to aircraft equipped with ADS-B In on the other link.

If you receive that transmission, it can cause your own aircraft to be displayed as a nearby target, usually slightly behind you and  $\pm 100$  to 200 feet in altitude, from the slight delay in the transmission reaching you due to the secondary surveillance radar processing and rebroadcasting delay.

Every ADS-B In system occasionally displays a ghost, even for those aircraft equipped with ADS-B Out. Entering your ownship ICAO can remove that identified ghost from the traffic screen.



Ownship ICAO can be entered manually using the OWNSHIP ICAO menu entry. Once entered, the value is saved but can be changed at any time.

If a uAvionix transponder is installed, and transponder control is enabled, ownship is automatically detected and entered for you on this screen. Manual override of this value is not permitted when transponder control is enabled.



### 7.8.9.2 Traffic Filtering

Traffic can be filtered by ownship relative altitude to reduce the information displayed on the screen. Ownship altitude is collected from one of multiple sources: ownship reports, GPS altitude, ownship barometric altitude.



Traffic filter selection options are Normal, Above, Below, Only Own and None. Full descriptions of each of these are found in Table 7-3 - Traffic Filter Options.



Figure 37 - Examples of Alternate Filter Values

Table 7-3 - Traffic Filter Options

Setting	Options	Description
Filter	Normal	Filter ownship, traffic above and below 2700 feet relative to ownship
	Above	Filter ownship, traffic above 8700 feet and below 2700 feet relative to ownship
	Below	Filter ownship, traffic above 2700 feet and below 8700 feet relative to ownship
	Only Own	Filter only ownship
	None	Displays all traffic
Ownship ICAO	Dependent on registration number	Press and release, then rotate center knob to select each number or letter associated with aircraft ICAO. This will allow for ownship filtering.

## 7.9 Reversionary AI



Figure 38 - Reversionary Attitude Indicator

The fourth page of the AI and DG operating modes, as well as the second page of the MFD operating mode, presents a reversionary style display of attitude and slip. When a transponder is interfaced, this page also allows control and monitoring of the transponder. This mode page cannot be customized by the pilot, but the transponder control can. See §7.10 - Transponder Control for details on transponder control.

### 7.10 Transponder Control

When installed and configured, the AV-30-E can be used to control select uAvionix transponders (including the BeaconX family). The transponder controls are available on the Reversionary AI page in each mode.

The reversionary AI page is accessed by pressing and releasing the right button repeatedly until AI appears in lower right corner of the display.

#### 7.10.1 Status

The transponder control user interface, as presented on the reversionary AI page, is shown below.



A	Configured Callsign / Flight ID
B	Current Squawk Code
C	Mode Selection (STBY, ON, ALT)
D	GPS NIC (integrity metric)
E	GPS NACp (accuracy metric)
F	Pressure Altitude - Green indicates radar interrogation and will change to IDT if IDENT is active
G	Communication status (see Table 7-4 - Transponder Status)

Figure 39 - Transponder Control

The current transponder status is indicated by the STAT field. The following status annunciations may be displayed.

Table 7-4 - Transponder Status

Status	Description
OK	Status good, no fault
NOPOS	No GNSS position information, ensure clear sky view
FAIL	Transponder device failure (broadcast monitor or transmission system)
TMOUT	Timeout, unable to communicate with transponder
MAINT	Maintenance required, ensure proper configuration (e.g., ICAO address)
WAIT	Retrieving configuration from transponder
FAULT	Unknown or generic fault

## 7.10.2 Changing Squawk

- Press and release the center knob
- Navigate highlighted cursor to desired digit by rotating the knob
- Press and release the center knob to select the squawk digit to change
- Rotate the center knob to change the highlighted squawk digit
- Press and release the center knob to accept the changed squawk
- Press and release the left button (*DONE*) to finish and save the setting

### 7.10.3 Changing Flight ID

- Press and release the center knob
- When the Squawk code is displayed, push and hold the center button again until FLIGHT ID appears
- Press and release to enter the first value
- Rotate center knob to change the Flight ID value. When desired value appears, push the center knob to accept the value
- Push and release the right button (CLEAR) at any time to clear the Flight ID completely
- Navigate highlighted cursor to desired character by rotating the knob
- Repeat until the entire Flight ID has been entered
- Press and release the left button (DONE) to finish and save the setting



Note: *No spaces are permitted in the FLIGHT ID*

### 7.10.4 Changing Transponder Mode

- Press and release the center knob
- Press and release the right button to cycle through each mode selection (STBY, ON, ALT)
- Press and release the left button (*DONE*) to finish and save the setting

### 7.10.5 To Send IDENT

- Press and release the left button

### 7.10.6 Quick Squawk VFR

BeaconX transponders store a VFR squawk code internally. By default, this is set to 1200 for U.S. operations, but may be changed in the transponder configuration.

In operation, there are two ways to change the squawk code to the default VFR code:

- Press and hold the left button until the VFR squawk code is shown in the SQWK field

- or -

- Press and release the center knob
- Press and release the center knob to select a squawk digit
- Press and release the right button to quick squawk VFR
- Press and release the left button (*DONE*) to finish

## 7.11 Brightness Menu

The brightness menu is activated by pressing and holding the lower right button until the brightness option appears.



Figure 40 - Brightness Menu

The left button toggles between AUTO BRT (automatic brightness mode), and MANUAL BRT (manual brightness mode).

When in manual brightness mode, utilizing the rotary knob, the display brightness setting can be adjusted from 1 to 100. When in automatic brightness mode, the display brightness adjusts set automatically based on the bezel-mounted photocell.

Pressing the DONE button will exit the menu and save the setting.

## 8 User Interface and Font Style Options

Three different cosmetic styles and two different fonts are selectable by the pilot. The three UI styles are LEGACY, EFIS and VINTAGE. The two font selections are ARIAL and LCD.



Figure 41 - UI Style Options

These settings only effect the displayed colors and font style – all functional operations are identical regardless of style settings.

## 9 Alerts and Alert Limits

### 9.1 Airframe Envelope Alerts

There are three airframe envelope alert types.

- Excessive Bank Angle Alerts
- Excessive G-Load Limit Alerts
- Excessive Angle of Attack (AoA) Limit Alerts

Figure 42 shows an example how the visual alerts are displayed.



Figure 42 – Example of Alert Annunciator on Screen

The priority and warning / alert levels, from the lowest priority to the highest priority are found in Table 9-1.



Table 9-1 – Envelope Alert Types and Priorities

Type	Priority	Percent	Aural	Visual
Roll	7	100%	“Roll”	ROLL
AoA	6	80%	One Tone	ANGLE
AoA	5	90%	Two Tones	ANGLE
AoA	4	100%	“Check Angle”	ANGLE
G Limit	3	80%	One Tone	G LIMIT
G Limit	2	90%	Two Tones	G LIMIT
G Limit	1	100%	“G Limit”	G LIMIT

The thresholds for each alert are pilot adjustable, and each alert type can be independently enabled or disabled.



Pressing the rotary knob when an alert is active will clear alert.

## 9.2 Altitude Alert

The Set Altitude alert is a visual alert only. It is signaled by the Set Altitude text display changing from white to green. Green indicates that the barometric corrected altitude is within  $\pm 100'$  of the Set Altitude.

# 10 Internal Battery Operation

## 10.1 General

The internal battery consists of a rechargeable battery system with automatic recharge, self-test, and power switching capability. The internal battery capacity will provide approximately 1 hour of operation at standard temperatures and 30 minutes (minimum) of operational capacity over the operational temperature range.

## 10.2 Battery Transition Logic

The battery is tested, enabled, and disabled based on airspeed and aircraft bus voltage.

### 10.2.1 Power-On Self-Test (Pre-Flight)

On powerup, the battery charge status will show “TEST” in amber. During this process, an internal load is being applied to the battery to determine general capacity capability. If the battery fails this self-test, the charge status field will show “FAIL” in red, and no battery capability will be available.

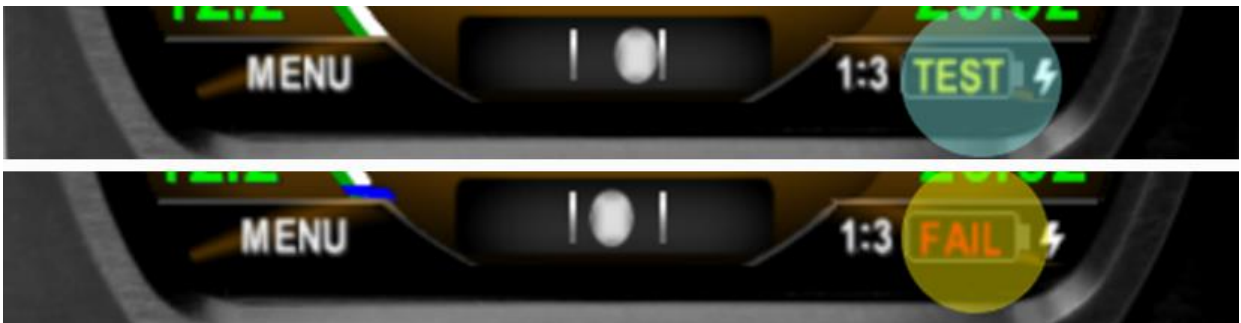

Figure 43- Battery Test Indicators



If the battery status shows “FAIL”, departure into actual or planned IFR conditions must not be performed.

### 10.2.2 Power Loss, Airspeed Above 40 Knots (In-Flight)

When in flight and the bus voltage drops below 7 VDC, the unit will automatically transition to internal battery operation; no pilot action is required for continued operation.

The “ON BATTERY” annunciation will be displayed:



Figure 44 - On Battery Operation

If bus voltage returns, the unit will automatically transition back to aircraft bus power; no pilot action is required. The “ON BATTERY” annunciation will extinguish.

### 10.2.3 Power Loss, Airspeed Below 40 Knots (On-Ground)

When on ground and the bus voltage drops below 7 VDC, the unit will initiate a shut-down sequence. This is the normal “on-ground” shutdown method. Pilot may discontinue the shutdown with any knob or button push.

If bus voltage returns, the shutdown sequence will automatically discontinue, and the unit will return to normal operating mode.

If bus voltage is not returned and the unit remains on, it can be shut down by pressing and holding the left and right buttons until screen goes black.

## 10.3 Battery Charge Status

The battery charge state is shown in percentage from 0 to 100. An internal battery charger will re-charge the battery if bus voltage is above approximately 10 VDC. The battery charge icon (presented adjacent to

the battery charge state), will be illuminated during the charge cycle as shown in Figure 45 - Battery Charge Status.



*Figure 45 - Battery Charge Status*

It is normal for the battery charge icon to intermittently flash during the battery charge cycle.

# 11 AoA Operation and Configuration

The following provides a description of how the derived Angle of Attack (AoA) operates and presents the corresponding AoA information to the pilot.

One of the main advantages of an AoA system is that it can provide an early indication of a stall, bringing enhanced awareness to the pilot.

 However, the AV-30-E system is supplemental in nature and does not replace the functionality provided by the aircraft's existing stall warning system.

## 11.1 Operational Methodology

Angle of attack is determined by comparing aircraft pitch to the aircraft flight path angle through the air. In level flight this directly corresponds to the angle at which the wing is intercepting the body of air surrounding the aircraft, with correlates to the current AoA.

Pitch is determined by the precision internal AHRS and flight path angle is determined by air-data based airspeed versus vertical speed measurements.

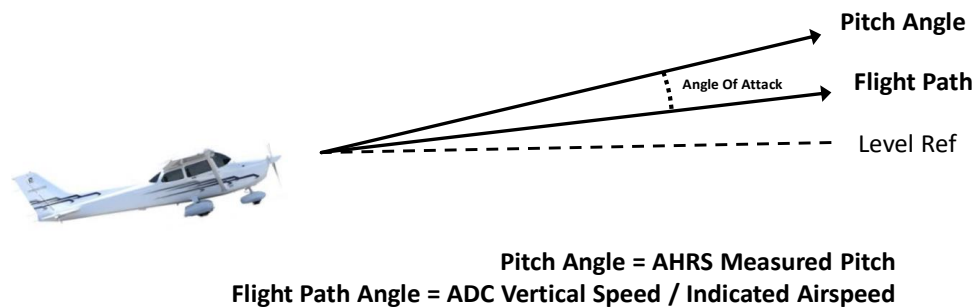

Figure 46 – AoA Computation

As an example of this relationship, during a climb, if the pitch angle is 10 degrees upward, and the aircraft's flight path through the air (forward

airspeed and vertical speed) is also 10 degrees upward, the equivalent AoA is 0 degrees. If, however, the pitch angle is 10 degrees upward, and the aircraft's flight path through the air is only 5 degrees, this corresponds to a positive 5-degree AoA.

A second example is where the pitch is 0 degrees, but the aircraft is descending. The AoA is then equivalent to the descent angle, which will be a negative AoA.

## 11.2 Configured Limits

As each aircraft make and model has different flight characteristics and post-production modifications such as altered wing tips, performance kits and other related modifications may change the flight dynamics of the aircraft, each aircraft has unique configuration limits that must be set for proper AoA operation.

An upper and lower configuration limit is pilot adjustable and provides the scaling mechanism for individual aircraft flight characteristics as it relates to the corresponding AoA display.

The upper near-stall configuration limit is set when the aircraft is in the "base-to-final" configuration with flaps and gear set to their normal positions for this maneuver. This provides the best protection when the aircraft is low-and-slow, and the pilot may inadvertently stall based on over-corrections.

- The upper limit is configured to coincide with the aircraft's existing stall warning system and is typically on the order of 10 to 15 degrees. This visually correlates to the first red bar on the AoA display with the second (upper most) red bar providing indication for operation between the aircraft's stall warning and actual stall point.
- A lower limit is configured to coincide with the AoA at which the aircraft flies under normal cruise conditions. This is typically on the order of 3 to 4 degrees. This visually correlates to the lowest one or two green bars on the AoA display.

The figure below shows how the configured upper and lower limits are mapped onto the color coded AoA indication.

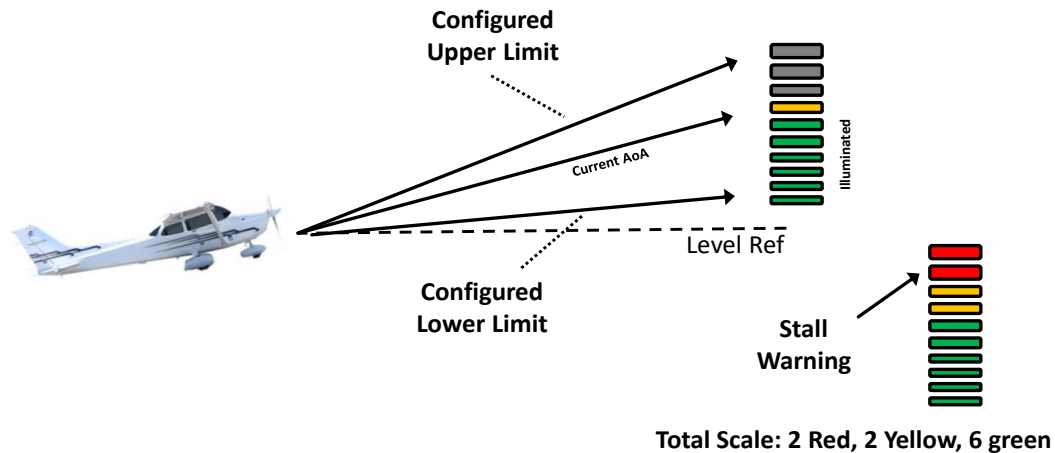

Figure 47 – AoA Upper and Lower Limits

### 11.3 Stable Flight Conditions

Stable flight conditions should be present when determining the upper and lower AoA limits. The in-flight procedures described should be executed when there is minimal turbulence, minimal crosswinds, and the pilot should operate the aircraft as closely as possible to the following:

- Stable power setting
- $\pm 5^\circ$  Heading
- $\pm 5$  Knots Airspeed
- $\pm 50$  Feet Altitude
- $\pm 50$  Ft/Min Vertical Speed

Any offsets beyond the parameters above may directly correlate with AoA errors.

### 11.4 Setting AoA Upper Limit

The objective is to set the upper AoA limit such that the first red bar illuminates at roughly the same time the aircraft's stall warning occurs.

To set the upper limit, the following procedure is recommended:

- At a safe altitude suitable for stalls, configure the aircraft for the normal base-to-final turn (typically gear and partial flaps extended).
- Slowly reduce speed and maintain a constant altitude, monitoring the display AoA as the aircrafts angle of attack increases.
- If the aircrafts stall-warning occurs prior to the indicator reaching the first red bar, the upper AoA limit needs to be numerically lowered to coincide with the aircrafts stall-warning point.
- If the aircrafts stall-warning occurs after the indicator has reached the first red bar, the upper AoA limit needs to be numerically raised to coincide with the aircrafts stall-warning point.
- See the Setup Menu instructions and adjust the upper limit.
- Repeat the above procedure as required.

## **11.5 Setting AoA Lower Limit**

The objective is to set the AoA lower limit to correspond with normal en route operation with one or two lower green bars illuminated.

- Configure the aircraft for normal en route operation (typically gear retracted and flaps fully retracted) and observe the AoA indication.
- If more than 2 “green” bars are showing, the lower AoA limit needs to be numerically lowered.
- If no “green” bars are showing, the lower AoA limit needs to be numerically increased.
- See the Setup Menu instructions and adjust the lower limit.





- Repeat the above procedure as required.

## 11.6 AoA Alert Types and Thresholds

Angle of attack alerts consist of both aural and visual alerts. Three alert levels are provided and are triggered on how close the current AoA is to the configured upper limit (as a percentage).

Table 11-1 - AoA Alert Limits

Level	Percent	Aural	Visual
Alert 1	80%	One Tone	
Alert 2	90%	Double Tone	
Alert 3	100%	“Check Angle”	

















When an alert is being generated, pressing any button will mute the alert. AoA alerts can also be completely disabled under the pilot preference settings.

## 11.7 Flap Setting Observations

When the upper AoA limit is configured for the “base-to-final” flap setting, and the lower AoA limit is configured for the normal “cruise” flap configuration, the indicated AoA will vary from this baseline when flaps are configured for other phases of flight. The pilot should document the actual indications provided for the various phases of flight.

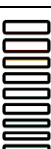
In Table 11-2, please highlight the actual AoA presentation for the indicated phase of flight.

Table 11-2 - AoA Observations

Flap Setting	Flaps Up	Flaps Down
Pre-Stall		
Climb Vx		
Climb Vy		
Cruise		
Best Glide Speed		
Approach		
1.3 Vs		
1.2 Vs		
1.1 Vs		

## 12 Setup Menu

The setup menu allows customization of settings that are pilot-accessible. Installer-only related settings are found in AV-30-E Installation Manual. Installation settings must be adjusted on the ground.

To access the Setup Menu, push the Menu button twice until the SETUP is shown in the lower window.



Figure 48 – Setup Menu Access

Rotating the knob left and right will access the various parameters that may be configured.



Figure 49 - AOA Alert Setting

Pressing the knob when the desired field is shown will allow the associated setting to be adjusted. After adjustment, pressing the knob again will exit editing mode. Pressing DONE or a lack of user input for 30 seconds will exit the setup menu and return to the primary screen.

### 12.1 Pilot-Accessible Setup Menu

Table 12-1 contains all the setup menu settings.

Table 12-1 - Setup Menu Settings

Setting	Description	Options / Setting Range
UI STYLE	Sets Visual Style	LEGACY, EFIS, VINTAGE
UI FONT	Sets Font Style	ARIAL, LCD
AUDIO VOL	Audio Volume for Alerts	0 to 10
AOA ALERT	Enable AoA Alerts	DISABLED, ENABLED
AOA HIGH LIM*	Upper AoA Limit	-28 to 30
AOA LOW LIM*	Lower AoA Limit	-30 to 28
G ALERT	Enable G Load Alert	DISABLED, ENABLED
G POS LIM	Positive G Limit	2 to 8
G NEG LIM	Negative G Limit	-1 to -8
ROLL ALERT	Enable Roll Alert	DISABLED, ENABLED
ROLL LIM	Roll Alert Threshold	30 to 80
TRAK STAB	Inertial Track Smoothing	DISABLED, ENABLED
HOURS	Lifetime hours of operation	For reference

\* Note: AoA limits cannot be changed unless the installation menu is enabled. Only enabling or disabling AoA Alerts is permitted when installation menu is disabled.



To access these settings, activate the INSTALLATION MODE by pressing the rotary knob in while initial power is being applied to the unit.

These settings are then available to be modified until the unit's power is cycled.



Also note that in this mode, an additional INSTALL mode menu is available. The pilot should not make any changes to the settings in this menu.

## **12.2 Non-Pilot Accessible Install Menu**

Non-Pilot Accessible settings and options range from air data and attitude trimming, display units and interface options. Contact an authorized facility to access and modify any of these settings.

## 13 AV-Link-E

### 13.1 Overview

The AV-Link-E is an integrated Wi-Fi bridge that allows for communication between AV-30-E and Wi-Fi enabled devices.

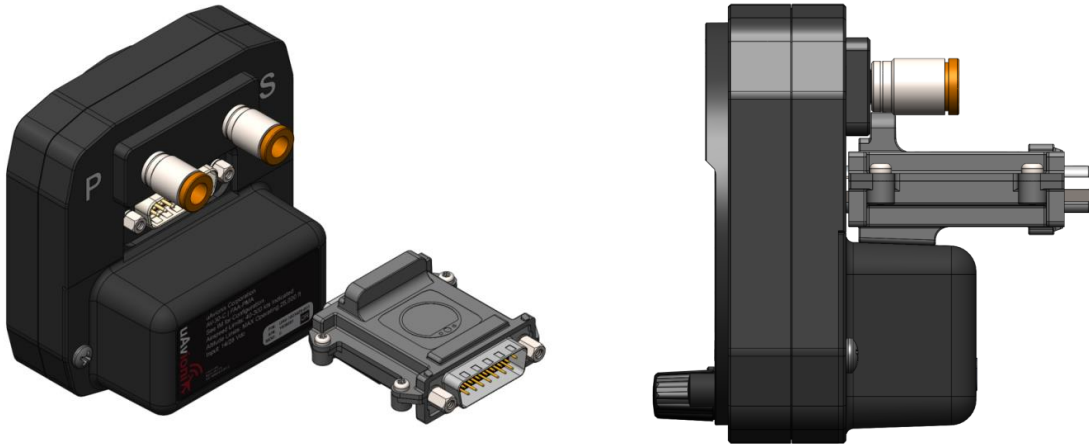



Figure 50 - AV-Link-E Attached to AV-30-E

The AV-Link-E allows for the integration of portable ADS-B devices such as Sentry and Sentry Mini to provide ADS-B traffic and GPS to an AV-30-E. Software updates for the AV-Link-E and AV-30-E can be performed via the embedded web page. AV-Link-E configuration settings and device status are also accessible through the embedded web page.

 The AV-Link-E accessory is not powered by the AV-30-E internal battery. Wi-Fi traffic data provided to the MFD mode will be unavailable during a power loss.

### 13.2 Additional Required Equipment

AV-Link-E is designed to interface with an existing Wi-Fi capable ADS-B receiver and the AV-30-E display. To fully take advantage of the AV-Link-E, the following equipment is required:

- AV-30-E Display
- ADS-B Receiver with GPS and Wireless capability

## 13.3 Connecting

Support for Windows, MacOS, iOS and other devices are supported, using the built-in web browser support on your computer. To connect to the AV-Link-E, configure your computer to connect to the AV-Link-E Wi-Fi connection.

1. Power the AV-Link-E by attaching AV-Link-E to AV-30-E to provide power. See AV-30-E Installation Manual for details.
2. Once the AV-Link-E is powered, on your computer, connect to the AV-Link-E Wi-Fi hotspot, which will have a “AV\_XXXX” SSID, where XXXX is a combination of alpha-numeric characters.

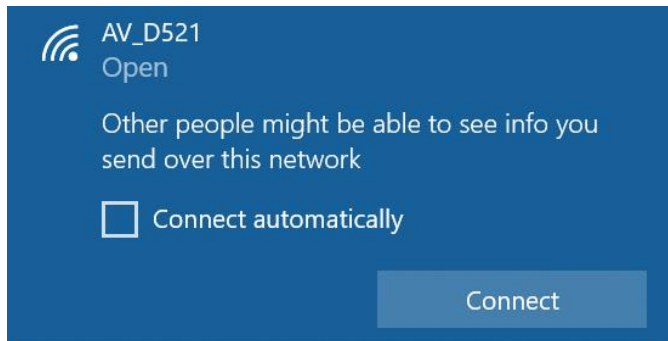

3. Once connected, use your web browser to navigate to 192.168.4.1. From there, you will see the AV-Link-E main web page.

## 13.4 Home Page

Note: Accessing the AV-Link-E web pages while in flight is not recommended and may disrupt normal operations of the AV-Link-E. All settings changes should be performed while on the ground.

The AV-Link-E main web home page provides both status information and methods to control settings. The screen is separated into three sections, the *Settings*, *Status*, and connected *Device Information*.

### 13.4.1 Settings

The settings panel contains information about the AV-Link-E. The firmware version, the AV-Link-E SSID, number of clients connected to the AV-Link-E and information about any ADS-B receiver connected via Wi-Fi.

Settings		
Firmware	<a href="#">0.2.39-AVLink</a>	
AVLink SSID	AV_3E35	
Clients	1	
ADS-B Receiver	Sentry_5D61	Connected

Status	
ICAO Address	000000
Callsign	-----
GPS Fix	3D
GPS Satellites	9
Position	42.0101504, -91.65808
Altitude (GNSS)	707 ft
Altitude (Baro)	946 ft

Device Information		
Hardware	Version	Serial Number
AV-Link	<a href="#">0.2.39</a>	1073510080
Sentry	2.4.44	400608855
AV-30	<a href="#">2.3.2</a>	3474897683187512000

[Wi-Fi Settings](#)   [Statistics](#)   [AV Firmware Update](#)   [Coredump](#)

### 13.4.2 Status

When connected to an ADS-B receiver, information received such as the ownship ICAO address, callsign, GPS location information as well as the current altitude is frequently updated.

### 13.4.3 Device Information

Connected devices, such as the uAvionix AV-30-E display or the Sentry ADS-B receiver, will be shown with the device serial number and version, if available. When the device is disconnected, it is removed from this list.



## 13.4.4 Navigating to Other Pages

Navigating to other AV-Link-E web pages is done using the web links at the bottom of the page.

[Wi-Fi Settings](#)

[Statistics](#)

[AV Firmware Update](#)

Wi-Fi Settings is used to configure the AV-Link-E and ADS-B Wi-Fi settings, Statistics is used to provide access to real-time system statistics and AV Firmware Update is used to update a connected AV-30-E display with new firmware.

## 13.5 Wi-Fi Settings Page

The AV-Link-E Wi-Fi settings page provide a way for the user to configure wireless connections. The screen is separated into two sections, the main Wi-Fi settings for the AV-Link-E (upper) and Wi-Fi settings for connecting to a remote ADS-B receiver (lower).

This will cover the lower settings section.

The screenshot shows a web browser window with the title 'AV-Link Wi-Fi Settings'. The address bar shows '192.168.4.1/settings'. The page content is divided into two main sections. The first section, 'Wi-Fi Settings', has a text input for SSID containing 'AV\_D521', a checked checkbox for 'Broadcast', a text input for Password, and a dropdown for Power Level set to '9'. The second section, 'ADS-B Receiver Settings', has a dropdown for SSID with 'Select a receiver' selected, a text input for Password, a text input for Port set to '4000', and a status indicator 'Scanning for receiver'. At the bottom of the form are three buttons: 'Save', 'Cancel', and 'Defaults'. A link for 'Main Page' is located at the bottom left of the page.

Figure 51 - AV-Link-E Wi-Fi Settings

### 13.5.1 ADS-B Receiver Settings

#### SSID

This is the Service Set Identifier (SSID) and is the primary name that is used for connecting to a remote ADS-B receive via Wi-Fi. If this value is set, the AV-Link-E will first attempt to connect to the named device.

When the AV-Link-E scans for available ADS-B receivers, the SSID drop down list is populated with the device names that it discovers.

If a custom ADS-B is desired, select 'Enter a custom receiver' and enter the name of the custom device.

If removing the custom ADS-B receiver is desired, select 'Remove custom receiver' and click Save.

## **AUTO CONNECT**

By default, AV-Link-E will automatically identify preferred uAvionix ADS-B devices and connect to them, making the initial use very simple.

If AV-Link-E has been configured with a preferred device and the named device is not available and Auto Connect is checked, then AV-Link-E will attempt to connect to any of the preferred uAvionix ADS-B devices it discovers.

If Auto Connect is checked, AV-Link-E will attempt to discover and automatically connect to uAvionix preferred ADS-B receivers. Examples of these are:

- Sentry
- Sentry Mini
- SkyEcho
- echoUAT
- skySensor

Unchecking Auto Connect will disable auto-discovery of uAvionix preferred ADS-B devices.

## **PASSWORD**

If password security is used on the ADS-B receiver, entering a password into this field, and clicking on Save will set this password. The password must be a minimum of 8 characters to meet security requirements.

## **PORT**

If the ADS-B receiver being used transmits GDL90 packets on a port that is different than 4000, entering the port number and clicking on Save will set this custom port. Valid values are 1-65535.

## **STATUS**

This status reference will frequently update with the current status of the Wi-Fi connection to your ADS-B receiver.

## 14 Autopilot

When installed and configured, the AV-30-E can be used to control a BendixKing xCruze / AeroCruze 100 / TruTrak Vizion (385 and PMA) or a Trio Pro Pilot autopilot. Heading, Set Altitude and Set Vertical Speed, and Autopilot Mode are selected on the AV-30-E and sent to the autopilot via a serial link. The controls are available in both AI and DG modes.

There are four autopilot direction modes as shown in Table 14-1- Autopilot Modes. The PUSH-SET menu sequence in autopilot configuration cycles through all settable controls and will not exit early when a value is changed. The PUSH-SET sequence includes SET BARO, HDG BUG, SET ALT, SVS, AUTOPILOT, and DG ADJ. The items and order of appearance will vary based on the autopilot mode and installation configuration.

Table 14-1- Autopilot Modes

AP Mode	Desired Direction	Current Direction	Desired Altitude	Desired Vertical Speed	PUSH-SET Sequence (DG mode <sup>(1)</sup> )	Auto Display Change	
						Indicator	AI/DG Direction
OFF	NA	NA	NA	NA	HDG BUG DG ADJ <sup>(2)</sup> BARO SET ALT SET VS AUTOPILOT	Heading Bug (used only for pilot reference)	NA/NA
HDG BUG	Heading Bug	DG Heading	SALT	SVS	HDG BUG DG ADJ <sup>(2)</sup> BARO SET ALT SET VS AUTOPILOT	Heading Bug	DG Tape/ DG Heading Rose
TRK BUG	Heading Bug (referenced to GPS Track)	GPS Ground Track	SALT	SVS	HDG BUG BARO SET ALT SET VS AUTOPILOT	Heading Bug	GPS TRK Tape/ GPS TRK HSI or ARC
WPT DTRK	Desired track to waypoint	GPS Ground Track	SALT	SVS	BARO SET ALT SET VS AUTOPILOT	Course "Needle" (Heading Bug hidden)	GPS TRK Tape/ GPS TRK

							HSI or ARC
WPT BRG	Bearing to waypoint	GPS Ground Track	SALT	SVS	BARO SET ALT SET VS AUTOPILOT	Bearing Bug (Heading Bug hidden)	GPS TRK Tape/ GPS TRK HSI or ARC

(1) In AI Mode BARO appears first followed by DG ADJ or HDG BUG

(2) DG ADJ appears last in the sequence if an AV-Mag is installed

## 14.1 Selecting Heading

- In AI mode, push and release the center knob multiple times until 'HDG BUG' appears
- In DG mode, either turn the center knob directly or push and release the center knob to bring up the 'HDG BUG' adjustment window
- Rotate the knob clockwise or counterclockwise to select the heading
- Push and release the center knob to advance to the next setting

## 14.2 Selecting Altitude

- Push and release the center knob to open the PUSH-SET menu
- Push and release the center knob until 'SET ALT' appears
- SALT has a default value of 5000' on first use but on subsequent uses the AV-30-E will recall the last value entered
- Rotate the center knob to set the desired SALT
- The SALT value displayed in the overlay field will change from white to green when the aircraft altitude reaches  $\pm 100'$  of the SALT value.
- The next push of the center knob will save the 'SET ALT' and bring up the 'SET VS' entry field

## 14.3 Selecting Vertical Speed

- If not already on the 'SET VS' entry field, push and release the center knob until 'SET VS' appears
- Note that the SET VS is initialized to the current vertical speed after a new SALT is entered. If SALT is not adjusted, then the last entered SVS is retained.

- Rotate the center knob to set the desired vertical speed
- Push and release the center knob to advance to the next setting
- Note: If in AI mode and the vertical trend indicator is visible, the magenta SVS bug will now appear on the vertical trend indicator. See §7.5.8 for more information about the vertical trend indicator. In DG mode, there are no SVS overlay indicators other than the value shown in the PUSH-SET menu.



*Figure 52 Selected Vertical Speed entry*

## 14.4 Selecting Autopilot Mode

- If not already on the 'AUTOPILOT' entry field, push and release the center knob until 'AUTOPILOT' appears
- Rotate the center knob to select the desired mode. The new mode is not engaged until you push and release the center knob.
- If the knob is not pushed and released within 30 seconds, the menu window will be dismissed automatically and the prior autopilot mode is retained
- When the new autopilot mode is selected, the display will automatically change to match the type of direction used in the mode. See Table 14-1- Autopilot Modes for the display changes that accompany autopilot mode selection.
- It is not recommended to undo the automatic display change to display a direction type that does not match the autopilot control type. I.e. do not display a DG heading rose when GPS ground track is sent to the autopilot and vice versa.
- The heading bug will not be settable nor will it be displayed when in 'WPT BRG' or 'WPT DTRK' modes

## 15 Stored Data Integrity Check

Configuration and calibration data stored in non-volatile memory is checked with Cyclic Redundancy Check (CRC) checksums on every power up event. If a data section is found to be corrupted, the user is notified at the power-up splash screen. In some cases, the corrupted values will be set to their defaults. Any additional restoration remedy varies with the type of data. See Table 15-1 - *Integrity Checked Data and Remedies* for details.

Table 15-1 - Integrity Checked Data and Remedies

Message	Data Type and Description	Remedy
"WARNING: OVERLAY reset to defaults. Reconfig required."	<p>Overlay settings.</p> <p>This data is used to determine which fields are active and which data are displayed in those fields.</p>	User to reconfigure overlay fields as per preference or installation log.
"WARNING: CFG reset to defaults. Reconfig required."	<p>Configuration settings.</p> <p>Trim settings, screen selection, AI/DG mode selection, function lock, etc.</p>	Re-set configuration items as per recorded setting in the installation log.
"ERROR: F-CAL values corrupted. Service required."	<p>Field Calibration.</p> <p>Magnetometer calibration, Altitude trim calibration, pitot-static zero point setting.</p>	Recalibration of the magnetometer if applicable, recalibration of the altitude trim if applicable, and re-zeroing of the pitot-static zero point if applicable.

<p>"ERROR: PROV values corrupted. Service required."</p>	<p>Provision settings. These are settings set at the factory.</p>	<p>Contact customer support. Cannot be reconfigured by the user.</p>
<p>"ERROR: Bootloader corrupted. Return to factory for service."</p>	<p>Bootloader software. Software that launches the main software after power-up.</p>	<p>Contact customer support. Cannot be reconfigured by the user.</p>



# 16 Operating Limits & System Specifications

Table 16-1 - Operating Limits

Operating Limits	
Attitude Rate Limit	±250 degrees per second
Attitude Operational Range	360° Roll, 180° Pitch
Attitude Accuracy	1° Static, 2.5° Dynamic
Airspeed Operational Range	40 to 300 kts
Altitude Operational Range	-1,000 to +25,000 ft
AoA Operational Range	-30° to +30°
AoA Resolution	1°
AoA Valid Speed Range	+35 to +300 kts
AoA Accuracy	2.5°
DALT Operational Range	-1,000 to +25,000 ft
DALT Accuracy	± 500 ft
TAS Operational Range	+35 to +300 kts
TAS Accuracy	± 20 kts
G-Load Operational Range	± 8 g
OAT Operational Range	-40°C to +70°C
OAT Accuracy	±4°C
Bus Voltage Range	7 to 35 Volts
Bus Voltage Accuracy	±1.0 Volt